

2

1

Neg. edge counting

F=30kHz

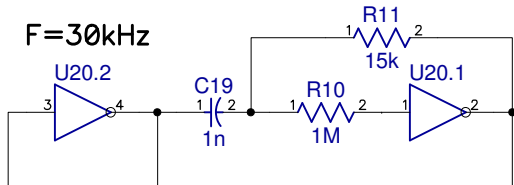

TIMING

Top board connector

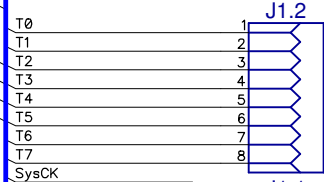

MATRIX

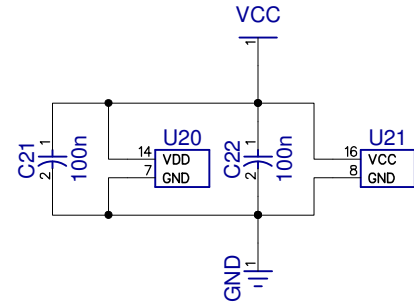

B

B

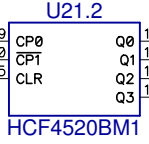
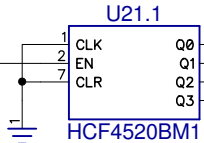

DisplayGating



Neg. edge on T7 triggers monostable



PS=SysCK|T3

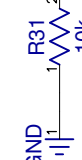

Game step time T=0.8RC

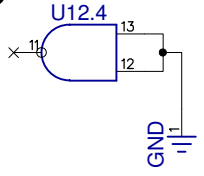
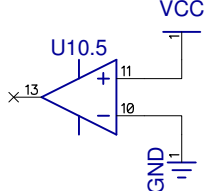

A

A

Title Game of Life Bottom board		
Size A4	Number Timing_Ctrl	Rev 1
Date 10.11.11		Drawn by Volkov
Filename		Sheet 2

2

1